



P7336
04575544
Edition 2
January 2014

Turbine Powered Starters

Series TS900

Installation and Maintenance Information



Save These Instructions

IR *Ingersoll Rand*

Product Safety Information

Intended Use:

These air starters are intended for use in starting reciprocating internal combustion engines. These starters are designed to be operated from a remote location after proper installation on the engine requiring starting.

For additional information refer to Air Starters for Internal Combustion Engines Product Safety Information Manual Form 45558624.

Manuals can be downloaded from ingersollrandproducts.com

Model TS900 Turbine-Powered Starter Operating Guidelines

WARNING

Failure to observe the following warnings could result in injury:

- Always release the start button immediately after the engine starts.
 - For safety, top performance, and maximum durability of parts do not operate Series TS900 Starters at air pressures over the pressure rating stamped on the nameplate. Use supply lines of adequate size as directed in the installation instructions in this manual.
 - Always turn off the air or gas supply and disconnect the air or gas supply hose before installing, removing or adjusting any accessory on this starter, or before performing any maintenance on this starter.
 - Series TS900 Starters are designed for gas operation. They are not totally sealed in dynamic operation since the exhaust must be vented or piped away and there is a possibility of leakage around the output shaft when rotating.
 - Caution should be taken when operating these starters on gas because of the danger of fire, explosion, or inhalation. After assembling a starter, always test in accordance with the procedures outlined in this manual. Never install a reassembled starter that has not been tested in accordance with the procedures in this manual.
 - Operate this starter only when properly installed on the engine.
 - Do not lubricate starters with flammable or volatile liquids such as kerosene or jet fuel. For personal protection, do not remove any labels. Replace any damaged label.
 - Use only recommended Ingersoll-Rand accessories.
-

Placing the Starter in Service

Installation

NOTICE

For maximum performance, read this manual prior to the installation or operation of Series TS900 Turbine-Powered Starters.

General Information

1. All pipe connections to the starter must be designed to provide continuously leak proof joints. Piping the starter should not impose stress on the starter as the result of operating vibration, thermal expansion or unsupported weight.
2. All piping, hoses, fittings and components must be clean, free of weld splatter, and any contamination that can enter the starter.
3. The exhaust of the starter has a 90° housing for use in piping away the exhaust (ST700K-350). Refer to Dwg. TPE_1002 for instructions.
4. The installation of the starter must comply with all appropriate specifications; such as torquing threaded fasteners and fittings, lubrication as installed and during operation, air (or gas) flow to and from the unit, cleanliness and safety.
5. It is required that a Strainer be installed in the inlet line for each starter. Ingersoll-Rand offers 3 sizes of Strainers: ST900-267-24 for 1-1/2 inch lines, ST900-267-32 for 2" lines and ST900-267-64 for 4" lines. These 300 mesh strainers provide 50 micron filtration and offer significant protection against supply line contaminants which could damage the turbine components. Replacement elements are ST900-266-24 for 1-1/2 inch, ST900-266-32 for 2", and ST900-266-64 for 4" lines.
6. All air (gas) line connections must be bubble tight. Ingersoll-Rand No. 5MB-441 sealant applied to clean threads will help assure a leak proof system.
7. In gas installations, all exhausts must be piped to a safer location. This applies to the exhaust from the Relief Valve and the Control Valve (SMB-G618 or 150BMP-2451B) as well as the starter exhaust.

8. If the supply air (gas) to the starter is at a higher pressure than that stamped on the nameplate of the starter, a pressure regulator must be installed in the supply line ahead of the relay valve. The pressure setting of the regulator is to be the operating pressure of the starter and not greater than the nameplate stamping. A relieving type regulator is recommended. If this type is not available it is important to install a relief valve between the regulator and relay valve. The opening pressure of the relief valve should be 15 psi. above the regulator setting.
9. The air supply lines between the relay valve, top control valve, and starter should be as short and free of fittings as practical.
10. The air supply lines should be arranged to provide drainage for condensation. This is especially important when the lines are long.
11. The starter, control components and air lines should be arranged so that they are protected from heat, vibration and contamination.
12. Apply a film of Dextron® *I Automatic Transmission fluid to the driving spline and mount the starter using the Mounting Cap Screws. Tighten the Mounting Cap Screws to 40-45 ft-lbs (54-61 Nm) torque.
13. Refer to Dwg. TPE_1004 for torque and lubrication specifications.

* Registered trademark of Exxon Corp.

Barring Over the Engine

The rotor shaft has a 1/4" hex socket in the end that can be used to rotate the engine shaft. This hex socket can be accessed by removing the directional exhaust 1/4" NPT plug from that housing to access the 1/4" hex socket.

Orientation of the Starter

Orientation refers to the rotational location of the lubrication ports in the Drive Housing, the rotational location of the air (gas) inlet, and if used, the rotational location of the directional exhaust cover. It is recommended that the correct orientation be ordered from the factory. If it is necessary to reorient the unit in the field, refer to Dwg. TPE_1001 and proceed as follows:

1. To rotate the Drive Housing relative to the inlet:
 - a. Remove the Cap Screws (35) holding the Drive Housing (32) to the Gear Case.
 - b. Rotate the Drive Housing to the required position. Do not remove the Drive Housing from the Gear Case (3).
 - c. Install the Cap Screws (35) and tighten to 28 ft.-lbs. (38 Nm) torque.
2. To rotate the Directional Exhaust cover with respect to the inlet:
 - a. Remove the Starter Assembly Cap Screws (6).
 - b. Rotate the Exhaust Cover to it's required position. Do not remove the Cover from the Motor Housing or separate the Motor Housing and Gear Case.
 - c. Reinstall the Cap Screws (6) and tighten them to 50 ft.-lbs. (68 Nm) torque in 20 ft.-lbs. (27 Nm) increments.

How to order a Starter

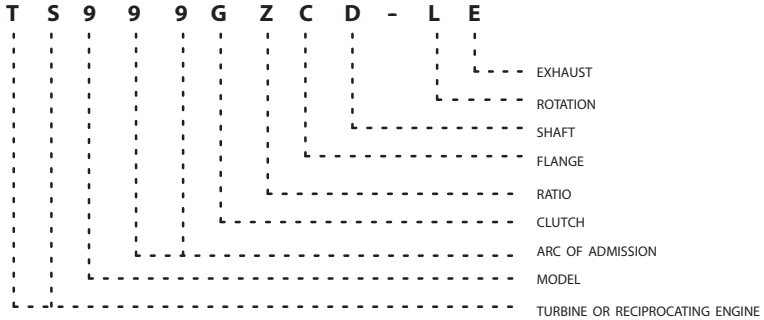

Series TS900 Turbine-Powered Starters are designed for air or gas operation in off-highway, marine and stationary applications.

Model	Supply Pressure psi/ K _{pa} Max	Pinion Data			
		No. of Teeth	Diametral Pitch	Pitch Diameter	PA
TS999GZFA-L	90/620	24	20/30	1.2	30
TS999GZCD-LE	90/620	16	20/30	0.8	30

* Pinion Code must be specified when ordering.

For different models or special applications, contact the nearest Ingersoll-Rand office or your distributor.

Mounting Dimensions for Series TS900 Starters

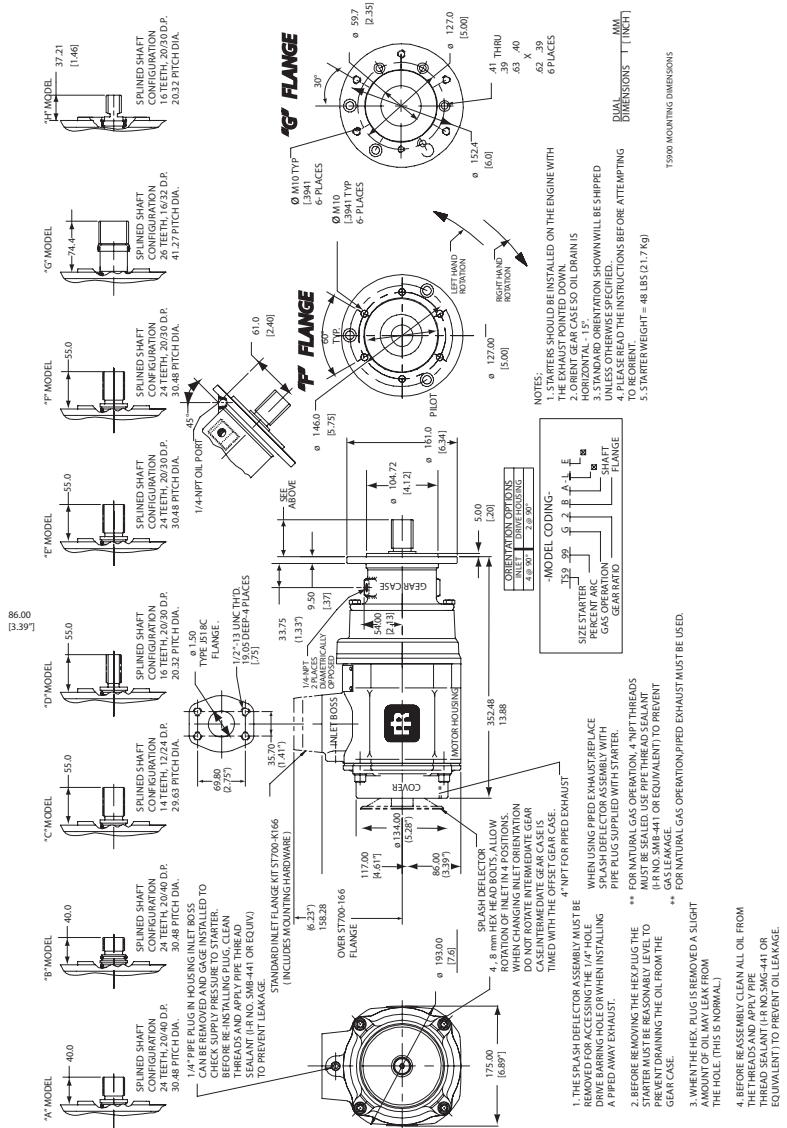

(Dwg. TPE_1001)

Piping Diagram for TS900 Turbine Installation

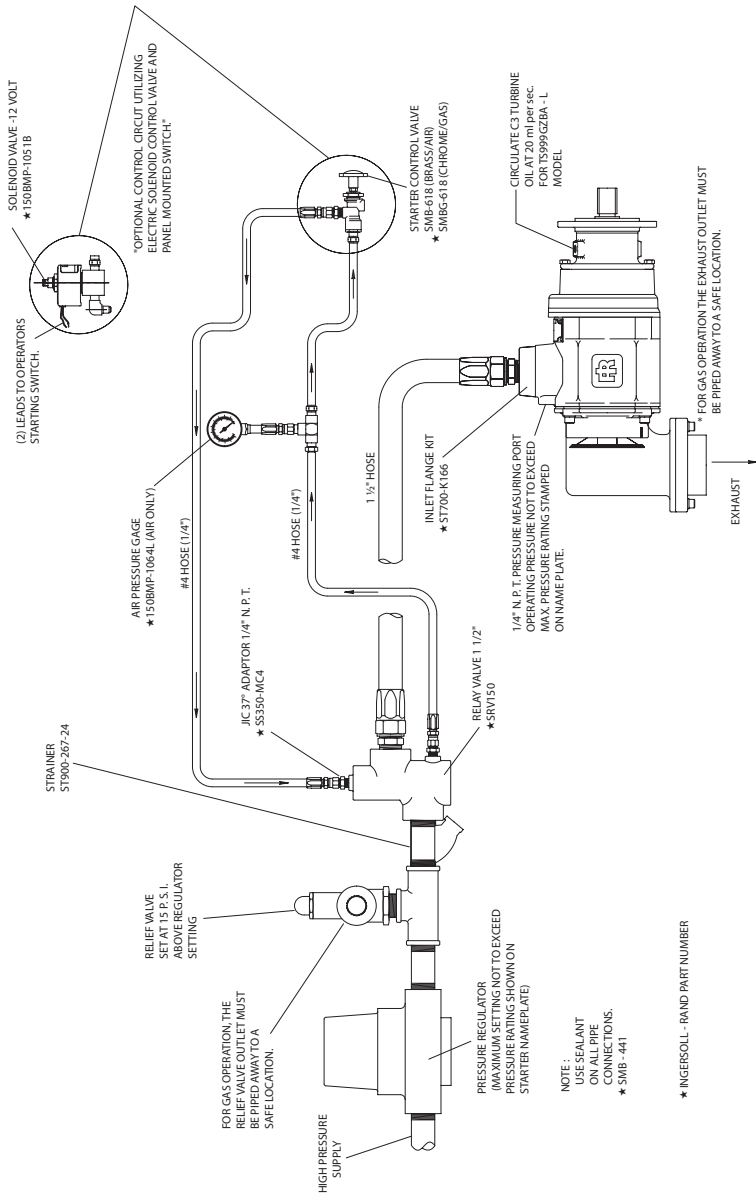

(Dwg. TPE_1002)

Piping Diagram for TS900 Multiple Starter Installation

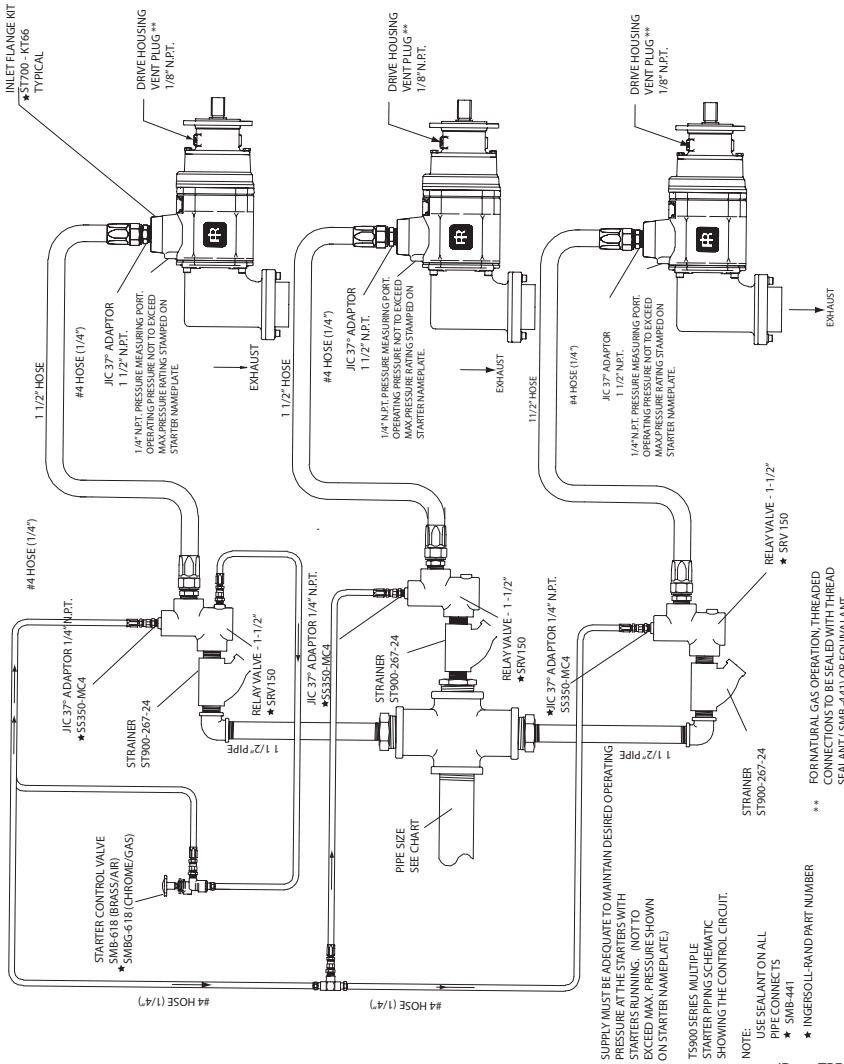

TS900	TS900
NO. STARTERS	90 PXS
MIN. PIPE SIZE	3"
	3-1/2"
	4
	3-1/2"
	4

SUPPLY MUST BE ADEQUATE TO MAINTAIN DESIRED OPERATING PRESSURE WITH STARTERS RUNNING EXCEED MAX. PRESSURE SHOWN ON STARTER NAMEPLATE.

TS900 SERIES MULTIPLE STARTER PIPING SCHEMATIC SHOWING THE CONTROL CIRCUIT.

NOTE:
 * USE SEALANT ON ALL PIPE CONNECTIONS
 * SMB-441
 * INgersoll-RAND PART NUMBER

** FOR NATURAL GAS OPERATION, THREADED CONNECTIONS TO BE SEALED WITH THREAD SEALANT (SMB-441) OR EQUIVALENT

(Dwg. TPE_1003)

TS900 Turbine Powered Starter - Section View

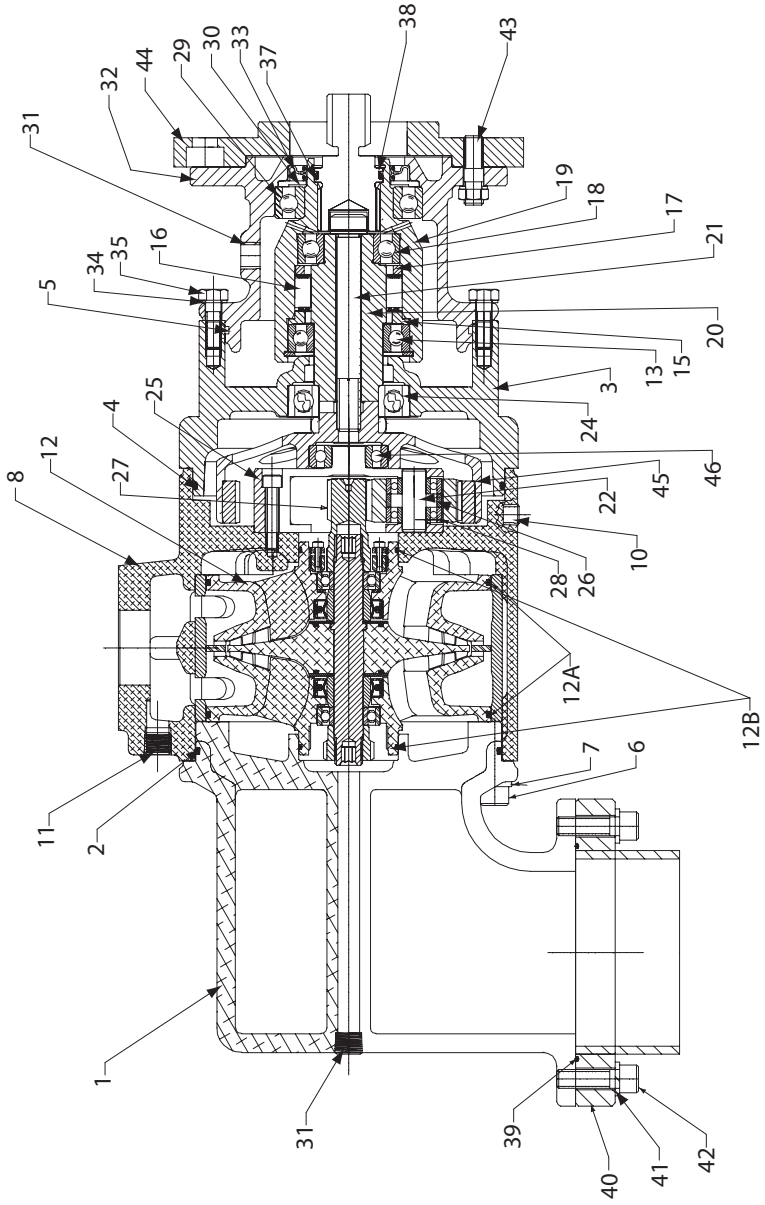

(Dwg. TPE_1005)

TS900 Turbine Powered Starter - Exploded View

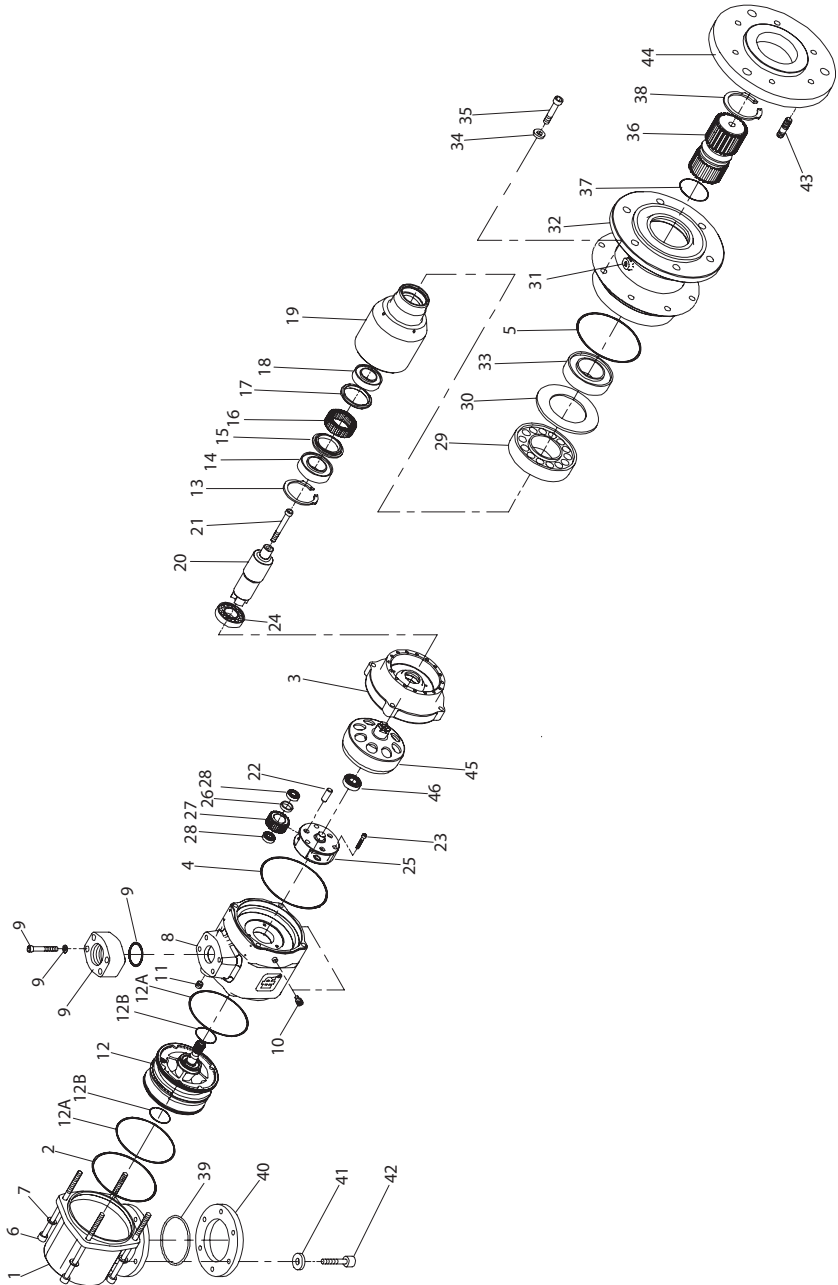

(Dwg.TPE_1006)

ST900 Turbine Powered Starter - Parts List

Item	Parts Description	Part Number	Item	Parts Description	Part Number
	Exhaust Kit	ST700--350	25	Frame	TS900--A108
1	Directional Housing Exhaust Cover	ST700--350	26	Spacer (3)	ST900--91
2	Exhaust Cover Seal	Y327--162	27	Gear (3)	ST900--10
*	Plug	ROH--377	28	Bearing (3)	ST900--24
3	Gear Case	ST900--372	29	Bearing	TS700--22
4	Rear Gear Case O--ring	Y327--163	30	Spacer	TS700--20
5	Front Gear Case O--ring	Y327--158	31	Pipe Plug (2)	ROH--377
6	Starter Assembly Cap Screw (4)	ST900--2574	32	Drive Housing	TS875--300
7	Cap ScrewWasher (4)	SS800--26	33	Seal	TS700--54
	Motor Housing Assembly	ST900--A40	34	Washer (8)	TE223A--415
8	Motor Housing	ST900--40	35	Cap Screw (8)	SS800--744
9	Inlet Flange Kit (includes Inlet Flange, Flange Mounting Bolts and Lock Washers)	ST700--K166	36	Splined Shaft A Model	TS710A--13F
			36	Splined Shaft D Model	04612834
*	Sight Glass	TS700--38	37	O--Ring	Y327--123
10	Housing Plug (2)	4564563	38	Snap Ring	TS700--16
11	Housing Plug Inlet Boss	4564530	39	O--Ring	Y327--046
*	Nameplate	ST900--301	40	Exhaust Flange	ST700--351
*	Nameplate Screw (4)	R4K--302	41	Lockwasher (6)	854--58
12	Motor Assembly	ST799R--A53A	42	Cap Screw (6)	ST700--703
12A	Motor O--Ring Seal (2)	ST700--67	43	Studs (6)	TS700--745
12B	Housing O--Ring Seal (2)	Y327--32	44	"C" Flange	04559464
13	Snap Ring	SS875--366	44	"E" Flange	04559175
14	Rear Bearing	SS875--399	45	Gear Ring	04334850
15	Spacer	SS875--367	46	Gear Frame Bearing	T06--24
16	Clutch	TS700--359	*	Tune--up Kit	TS700--TK1
17	Spacer	TS700--368	*	Rebuild Kit	TS700--RM1
18	Front Bearing	SS875--278	* Not Illustrated		
19	Clutch Housing	TS875--14			
20	Drive Shaft	TS700--85			
21	Cap Screw	TS700--255			
22	Shaft (3)	ST900--191			
23	Cap Screw	45518586			
24	Bearing (1)	TA--22			

Motor Assembly Diagram

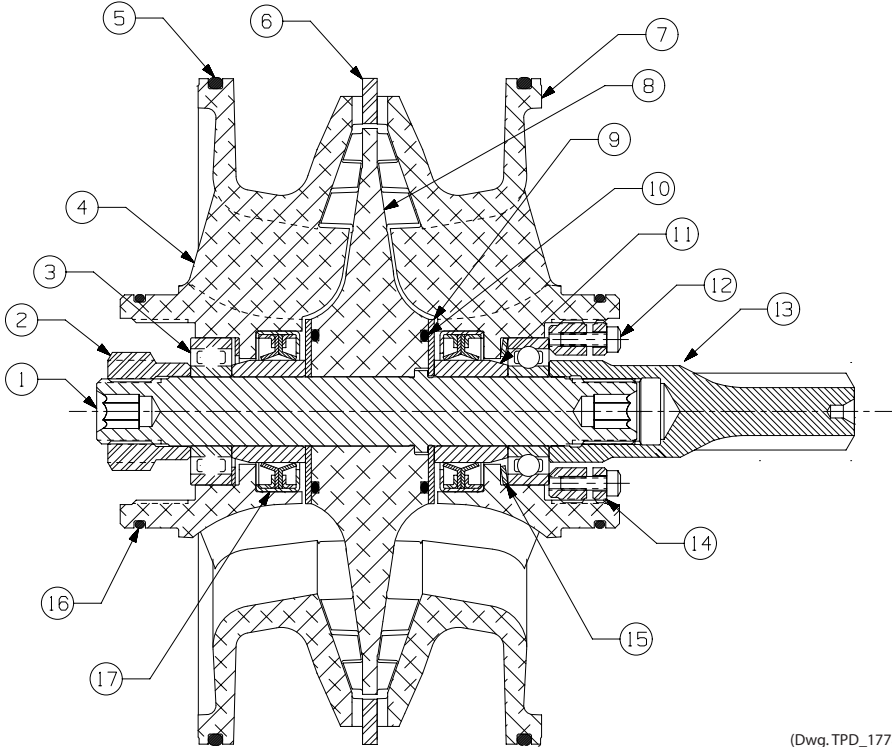

(Dwg.TPD_1778)

Motor Assembly Parts List

Item	Part Number	Part Description	Qty.
1	*	Shaft	1
2	*	Nut	1
3	*	Bearing	2
4	*	End Plate	1
5	*	O-ring	2
6	*	Spacer	1
7	*	End Plate	1
8	*	Rotor	1
9	*	Spacer	2
10	*	Seal	2
11	*	Spacer	2
12	*	Screw	2
13	*	Pinion	1
14	*	Nut	1
15	*	Washer	1
16	*	O-Ring	2
17	*	Seal	2

* These Parts only available as an Assembly.

Maintenance

WARNING

Always wear eye protection when operating or performing any maintenance on this starter. Always turn off the air supply and disconnect the air supply hose before installing, removing or adjusting any accessory on this starter or before performing any maintenance on this starter.

Lubrication

Each time a Series TS900 Starter is disassembled for maintenance or repair, lubricate the starter as follows:

1. Lubricate all o-rings with o-ring lubricant.
2. Add 300 ml (approximately 3/4 pint) of C32 Grade Turbine Oil through the side plug hole in the Motor Housing (8).
3. Wipe both end splines of splined shaft with Ingersoll-Rand No. 130 Grease.
4. Add 15 ml of C32 grade turbine oil at (31) plug in exhaust cover.

Disassembly

General Information

1. Do not disassemble the Starter any further than necessary to replace worn or damaged parts.
2. When grasping a part in a vise, always use coppercovered vice jaws to protect the surface of the part and help prevent distortion. This is particularly true of threaded and die cast members.
3. Do not remove any part which is a press fit in or on a subassembly unless the removal of that part is necessary for replacement or repairs.
4. Always have a complete set of seals and O-rings on hand before starting any overhaul of a Series TS900 Turbine Starter. Never reuse old seals or O-rings.
5. Mark adjacent housings so they can be reassembled into the same relative positions with adjacent center punch marks on the out side of the flanges on the Exhaust Cover (1), Motor Housing (8), and Gear Case (3). A quick drying marking pen can be used as an alternative.
6. Do not press any bearing on a part unless you have new bearings on hand for installation. Bearings are always damaged during the removal process.

Housing Exhaust Cover, Motor Assembly, and Motor Housing.

1. If replacing the Motor Assembly (12), remove Housing Plug (10) and drain the oil from the gearing before beginning disassembly of the Starter. Inspect the Magnetic Housing Plugs (10) for metal particles. Very fine metal particles are normal. Remove particles and reinstall plugs. Large particles or chips are an indication of a problem. If apparent, disassemble Gear Case (3) and inspect.
2. Using an 8 mm Hex-head wrench, unscrew and remove the Starter Assembly Cap Screws (6) and Washers (7).
3. Pull the Housing Exhaust Cover (1) from the Motor Housing (8). To dislodge the Housing Exhaust Cover, rotate it until the ears clear the Motor Housing. Using a plastic hammer, tap the ears alternately until the Housing Exhaust Cover can be removed from the Motor Housing. Refer to Dwg. TPD_1782.

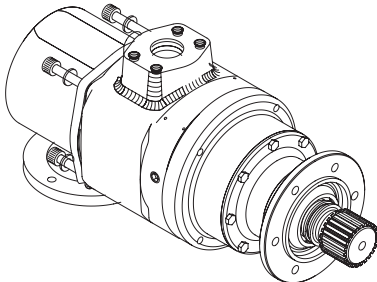

(Dwg. TPD_1782)

4. To disassemble the Housing Exhaust Elbow and components. Refer to Dwg. TPD_1773.

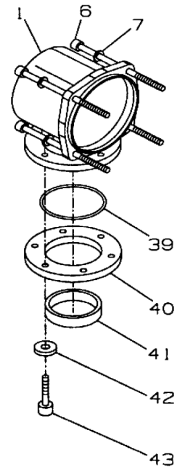

(Dwg. TPD_1773)

5. Tap the Motor Housing with a plastic hammer to dislodge it from the Gear Case (3).

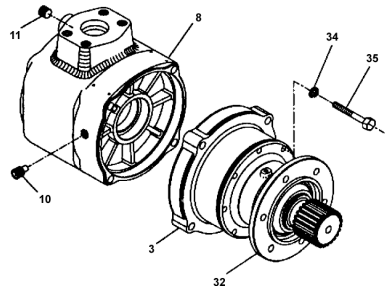

(Dwg. TPD_1774)

- Grasp the rear of the Motor Assembly (12) and pull from the rear of the Motor Housing. If the Motor Assembly is difficult to remove, lightly, push the motor pinion which is in the front of the Motor Assembly toward the exhaust side of the Motor Housing in order to free the Motor Assembly. The Motor Assembly (12) is replaced as a unit and not disassembled in the field. Refer to Dwg. TPD_1783.

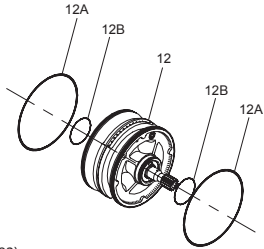

(Dwg. TPD_1783)

Drive Housing and Gear Case Disassembly

- Remove the 8 Hex Head Cap Screws (35) that hold the two housings together. Refer to Dwg. TPD_1775.

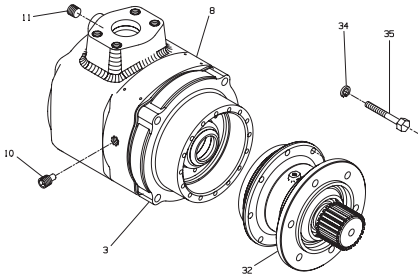

(Dwg. TPD_1775)

- Using two pry bars on opposite sides of the assembly, carefully pry the two housings apart.
- To remove the Splined Shaft (36) from the Clutch Shaft (19), remove Snap Ring (38).
- Using a 10 mm wrench remove the Cap Screw (21) from the Clutch Shaft.
- Remove the clutch assembly from the Gear Case. The clutch assembly is replaced as a unit from the opposite side of the Gear Case and not disassembled any further in the field.

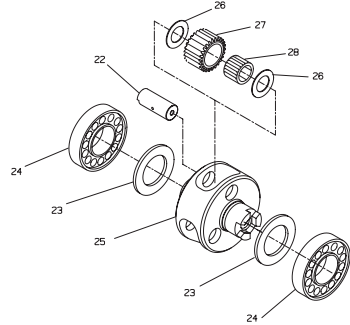

(Dwg. TPD_1776)

- Remove the Planet Frame (25). Refer to Dwg. TPD_1776.
- Using a bearing puller remove the two Bearings (24) from the planet frame (25).
- The two Gear Shaft Retaining Washers (23) can be removed from the Planet Frame.
- The three Planet Gear Shafts (22) can be pushed from the planet frame.

CAUTION

This will free for removal the Planet Gears (27), the Bearing Spacers (26), and the Needle Rollers (28).

Assembly

General Instructions

- Always press on the inner ring of a ball bearing when installing the bearing on a shaft.
- Always press on the outer ring of a ball bearing when pressing the bearing in a bearing recess.
- Whenever grasping a part in a vise, always use leather-covered, copper-covered vise jaws to protect the surface of the part and help prevent distortion. This is particularly true of threaded and die cast parts.
- Always clean every part, and wipe every part with a thin oil film before installation.
- Note the orientation markings that were placed on the mating flanges before disassembly and assure the assembled unit is arranged as before disassembly.
- Coat all O-rings and the contact surface on their mating parts with o-ring lubricant immediately before assembling those parts.
- When pressing parts together, assure that the parts are located firmly against a shoulder or otherwise positioned as specified.

Assembly of the Directional Housing Exhaust Cover

- Coat the Exhaust Cover Seal (2) with o-ring lubricant and install in the groove in the Directional Housing Exhaust Cover (1).
- Install Directional Housing Exhaust Cover on the rear of the Motor Housing (8) in the desired orientation and using a plastic hammer, tap the Directional Housing Exhaust Cover until it seats.

NOTICE

Use **Loctite® 56747** Pipe Sealant on all plugs.**

- Place the starter in a vertical position with Exhaust Elbow Plug (31) up. Pour 15 ml of C32 Grade Turbine Oil and replace Plug.
- Install the bottom Housing Plug (10) with Loctite® 56747 and the Housing Plug Inlet Boss (11). Put the Starter on its side with the side plug hole upward. Add 300 ml (approximately 3/4 pint) of C32 Grade Turbine Oil through the side plug hole in the Motor Housing (8).

NOTICE

Change oil annually or every 500 starts.

** Registered trademark of Loctite Corporation.

Clutch Assembly

NOTICE

The Clutch should be replaced after 1500 starts.

1. Press the Front Clutch Bearing (18) onto the Drive Gear Shaft (20).
2. Insert the Shaft Bearing Assembly into the Clutch Housing (19). If necessary, tap into position with a plastic hammer using the correct adapter.
3. With the Clutch Shaft in a vertical position, insert in sequence, Spacer (17), the Clutch (16), and Spacer (15). For opposite rotation units (right hand or counter clockwise starter rotation), reverse the clutch orientation from that shown in Dwg. TPD_1793.

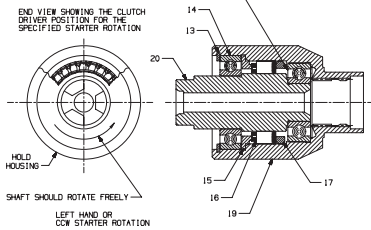

(Dwg. TPD_1793)

4. Using a 28 mm maximum diameter Gear Shaft support which extends through the splined end of the Clutch Shaft, carefully press the Rear Clutch Bearing (14) into place.
5. Install the Retaining Ring (13) into the Clutch Shaft.
6. Press the Bearing onto the Clutch Shaft (20) so that it seats against the shoulder on the shaft.

Gear Case Assembly

1. Assemble Gear Shaft Retaining Washer (23) onto end of Planet Frame opposite the driving dogs. The counterbored side of the Washer must be towards the Planet Frame.
2. Press Bearing (24) onto Planet Frame so that it seats against the Washer.
3. Carefully slide Gear (27) onto the Planet Frame so that the holes line up.
4. Remove the Shaft from the vise, holding it by the plain end, and position it so that the step on the opposite end lines up with the Retaining Washer on the opposite side of the Planet Frame. Slide it into the Planet Frame, through the Gear and through the opposite side of the Planet Frame. Tap lightly with a plastic hammer if necessary. Repeat this procedure for each Planet Gear.
5. Screw in 3 cap screws (23) to secure gears.
6. Press the Planet Frame Bearing (46) onto the Planet Frame so that it seats against the frame.
7. Press Shaft Seal (33) into the front of the Drive Housing (32). The metal case of the Seal must enter the housing first.
8. Place the Motor Housing Assembly in a vertical position with the Gear Case end up. Assemble the Planet Gear Frame by fitting the Bearing (24) into the bore in the Motor Housing.
9. Assemble the O-ring (4) onto the Gear Case (3).

10. Carefully set the Gear Case down over the Planet Frame Assembly and onto the Motor Housing. Rotate the Gear Case slightly as needed to engage the Planet Gear Teeth into the internal Gear in the Gear Case. Rotate the Gear Case onto the indicated orientation and tap into position with a plastic hammer.
11. Lay the assembly over its side and thread the Starter Assembly Capscrews (6) with Lockwashers (7) onto the four holes. Alternately tighten the screws to 50 ft.-lb. (68 Nm) in 10--15 ft.-lb. (16 Nm) increments.
12. Assemble the Clutch Assembly into the Planet Frame. Make sure that the driving dogs on the Planet Frame mesh with the driving dogs on the Drive Gear Shaft.
13. Insert the Screw (21) with Loctite 242 through the Drive Gear Shaft and thread onto the Planet Frame. Tighten to 90 ft.-lb. torque (122 Nm). For right hand rotation, hold the Clutch Shaft with a strap type wrench.
14. Assemble the O-ring (5) onto the Drive Housing (32).
15. Carefully lower the Drive Housing down over the Clutch Assembly onto the face of the Gear Case being careful not to damage the top of the Housing Seal. After the seal has been positioned onto the Clutch Shaft, the Drive Housing can be tapped onto place with a plastic hammer.
16. After positioning the Drive Housing to the orientation marks, thread the eight Capscrews (35) and Lockwashers (34) onto the tapped holes in the Gear Case. Tighten the cap screws to 28 ft.-lb. (38 Nm) torque.
17. Assemble the O-ring (37) onto the Splined Shaft (36). Carefully insert it into the Clutch Shaft. Tap it into place with a plastic hammer. Insert the Snap Ring (38) into the Clutch Shaft (19).

Test and Inspection Procedure

1. Turn the Splined Shaft by hand in the direction of starter rotation. It should turn freely and easily.
2. Turn the Shaft in the opposite direction. It will be more difficult to turn; however, it should turn smoothly with no binding. Turn the shaft through 12 to 15 revolutions.
3. Confirm orientation by referring through to previously placed markings or installation drawing.
4. Secure starter in a vise and apply 90 psi (6.2 BAR/620kPa) pressure using a 3/8" (9 mm) supply line to the inlet of the motor. The starter should run smoothly. Confirm that the Splined Shaft is turning in the correct direction. If applicable, confirm that the exhaust deflector returns to its normal position after the air is turned off.
5. With the starter immersed in a non-flammable, bubbleproducing liquid, slowly apply 20 psi (1.38 Bar/138 kPa) to the inlet of the motor for 30 seconds. No bubbles should appear.

Troubleshooting Guide

Trouble	Probable Cause	Solution
Motor will not run	No air supply	Check for blockage or damage to air supply lines or tank.
	Damaged Motor Assembly (12)	Inspect Motor Assembly and power train and repair power train or replace Motor Assembly if necessary.
	Foreign material in Motor and/or piping	Remove Motor Assembly and/or piping and remove the blockage.
	Blocked exhaust system	Remove Housing Exhaust Cover (1) and check for blockage.
	Defective Control Valve or Relay Valve	Replace Control Valve or Relay Valve.
Loss of Power	Low air pressure to Starter	Check air supply.
	Restricted air supply line	Check for blockage or damage to air lines.
	Relay Valve malfunctioning	Clean or replace lines or Relay Valve. Lubricate Relay Valve.
	Exhaust flow restricted	Check for blocked or damaged piping. Clean or replace piping. Check for dirt or foreign material and clean or remove. Check for ice build-up. Melt ice and reduce moisture build-up to Starter.
	Damaged Motor Assembly	Replace Motor Assembly.
Oil blowing out of exhaust	Oil in air supply line.	Inspect air line and remove source of oil.
	Splash Deflector Retaining Screw (31) or pipe plug missing	Install Splash Deflector Retaining Screw or pipe plug.
	Worn or damaged rotor seals or static O-Rings	Replace static seals on outside of Motor or send Motor to Ingersoll-Rand to be rebuilt.
Oil leaking from Gear Case	Worn or damaged O-Rings	Replace O-Rings.
	Loose joints	Make sure that joints fit properly and Starter Assembly Cap Screws are tightened to 50 ft-lb (68 Nm) torque. Make sure all seals and O-Rings fit and seal properly at their perimeters. If they do not, replace with new seals and O-Rings.
	Excessive high-speed operation	Operate according to recommendations.
	High number of start cycles	Replace worn components.
	Loose or leaking Pipe Plugs (31) (11)	Tighten or replace Pipe plugs using Ingersoll-Rand SMB-441 Pipe Sealant.
	Splash Deflector Retaining Screw or pipe plug missing	Tighten Splash Deflector Retaining Screw or replace pipe plug.
Air or gas leakage	Loose Joints	Make sure that joints fit properly and that Starter Assembly Cap Screws are tightened to 50 ft-lb (68 Nm) torque. Make sure that all seals and O-Rings fit and seal properly at their perimeters. If they do not, replace with new seals and O-Rings.
	Excessive high-speed operation	Operate according to recommendations.
	High number of start cycles	Replace worn components.
	Loose or leaking Pipe Plugs	Tighten or replace pipe plugs.
	Splash Deflector Retaining Screw loose or pipe plug missing	Tighten Splash Deflector Retaining Screw or replace pipe plug.

TS900 Maintenance Schedule

Starts	Components	Recommendation
500	C3 Turbine Oil	Change
500	All External Cap Screws	Check Torque
500	Strainer	Check Element
1000	C3 Turbine Oil	Change
1000	All External Cap Screws	Check Torque
1000	Strainer	Check Element
1500	C3 Turbine Oil	Change
1500	All External Cap Screws	Check Torque
1500	Strainer	Check Element
1500	Clutch, TS900-359	Change
1500	Rear Bearing, SS875-399	Change
1500	Front Bearing, SS875-278	Change
1500	Seal, TS700-54	Change
1500	O-ring, Y327-158	Change
1500	O-ring, Y327-123	Change
1500	Bearing, TS700-22	Change
2000	C3 Turbine Oil	Change
2000	All External Cap Screws	Check Torque
2000	Strainer	Check Element
2500	C3 Turbine Oil	Change
2500	All External Cap Screws	Check Torque
2500	Strainer	Check Element
3000	C3 Turbine Oil	Change
3000	Clutch, TS900-359	Change
3000	All External Cap Screws	Check Torque
3000	Strainer	Check Element
3000	Rear Bearing, SS875-399	Change
3000	Front Bearing, SS875-278	Change
3000	Seal, TS700-54	Change
3000	O-ring, Y327-158	Change
3000	O-ring, Y327-123	Change
3000	Bearing, TS700-22	Change
3500	C3 Turbine Oil	Change
3500	All External Cap Screws	Check Torque
3500	Strainer	Check Element

Parts and Maintenance



The use of other than genuine Ingersoll Rand replacement parts may result in safety hazards, decreased motor performance, and increased maintenance, and may invalidate all warranties.

Ingersoll Rand is not responsible for customer modification of Starters for applications on which Ingersoll Rand was not consulted. Repairs should be made only by authorized trained personnel. Consult your nearest Ingersoll Rand Authorized Service center.

When the life of the Starters has expired, it is recommended that the Starters be disassembled, degreased and parts be separated by material so that they can be recycled.

Manuals can be downloaded from ingersollrandproducts.com

Refer all communications to the nearest **Ingersoll Rand** Office or Distributor.

Notes:

Notes:

Notes:

ingersollrandproducts.com

© 2014 Ingersoll Rand

