



MSG[®] Centrifugal Compressors

Air Separation and Industrial Gases



Your Trusted Partner in Compressed Gas

Efficient operation of your air separation facility relies heavily on an advanced compressed gas system that boosts productivity, lowers operating expenses and extends equipment life. No matter the industry or application, you can count on Ingersoll Rand® as a trusted partner for centrifugal compression technologies and services for superior performance.

Take a Systems Approach

Delivering reliable compressed gas to your process goes well beyond the compressor itself. To maximise performance, it is imperative to manage the entire lifecycle of your compressed gas system.

Your system can be optimised at many points—from design to operation to overhaul. Your operation will benefit from Ingersoll Rand's partnership through our extensive experience and global expertise to ensure reliability, lower maintenance costs and ease of service.



Let's Get Started Together
Ingersoll Rand Contracting Services Video





A History of Innovation

- 1955 Joy Manufacturing Co. established facility in Buffalo, N.Y.
- 1960 First small integrally geared centrifugal compressor introduced
- 1965 First commercial centrifugal compressor package
- 1971 First four-stage, nitrogen recycling machine for liquefaction of industrial gases
- 1980 First microprocessor-controlled compressor launched
- 1987 Cooper Industries Inc. purchases Joy Manufacturing Co.
- 1988 First seven-stage, dual-service machine with three pinons in each gearbox
- 1995 Cooper Cameron Corporation established
- 2001 First natural gas compressor delivered
- 2002 Cooper Energy Services and Cooper Turbocompressor combine to form Cooper Compression
- 2004 MAESTRO™ series of control systems introduced
First CO₂ gas compressor delivered
- 2005 First mixed-refrigerant compressor for LNG liquefaction
MSG® and TURBO-AIR® compressor manufacturing begins in China
- 2006 Company name changed to Cameron
First hydrogen compressor delivered
- 2008 First CO compressor for HyCO process application delivered
- 2009 MSG-18 introduced
ISO 8573-1 Class Zero Certification awarded
- 2012 200th process gas compressor delivered
- 2013 MSG TURBO-AIR NX 12000 introduced
First propylene compressor delivered
- 2015 Ingersoll Rand acquires Cameron's Centrifugal Compression division
TURBO-AIR production in China moved to Wujiang campus
- 2016 TURBO-AIR NX 8000 introduced
- 2019 Grand opening of state-of-the-art MSG production and test laboratory facility at Wujiang



MSG Integrally Geared Centrifugal Compressors

Compare the innovative centrifugal compressor technology of the MSG with other compressors, and the advantages are clear.

MSG CENTRIFUGAL COMPRESSORS	OTHER COMPRESSORS
 <p>LOW MAINTENANCE</p> <ul style="list-style-type: none"> • Compression elements don't require periodic replacement • Accessible horizontally split gearbox for quick inspection • Removable intercooler and aftercooler bundles for easy cleaning • Oil and seal gas filter elements are easily replaced online 	<ul style="list-style-type: none"> • Require regular maintenance, such as replacement of piston rings, gland packing and valve plates, or periodic replacement of air ends • Result in high operating expenses and significant machine downtime
 <p>OIL-FREE GAS</p> <ul style="list-style-type: none"> • 100% oil-free gas • Prevents system contamination • No costly waste disposal associated with oil-laden condensate • Eliminates the expense and maintenance of oil separation filters at the discharge 	<ul style="list-style-type: none"> • Oil filters must be installed at discharge • Potential for oil carryover to foul the process • Oil-free claim is based dependent on uninterrupted seal gas supply
 <p>RELIABILITY</p> <ul style="list-style-type: none"> • Centrifugal compressors have industry leading 99.7% MTBF • Conservative high-quality gear design and stainless steel compression elements • Long-life pinion bearing design • Highly resilient to surge events 	<ul style="list-style-type: none"> • Contacting compression elements are subject to wear • Limited rotating element life • Designed-in wearing items to generate aftermarket revenues • Require costly surge control systems to avoid damage to seals and bearings
 <p>OPTIMUM CONTROL</p> <ul style="list-style-type: none"> • Inlet guide vane control and bypass for consistent gas delivery • Automatic operation and precision control for most operating conditions • State-of-the-art MAESTRO-suite of controls • PLC control systems available 	<ul style="list-style-type: none"> • Expensive, variable-frequency controls may be required to adjust capacity • Cylinder unloading for stepped flow control can result in complicated process control due to sudden changes in capacity
 <p>COMPACT INSTALLATION FOOTPRINT</p> <ul style="list-style-type: none"> • Single-lift skid or flexible modules • Easy installation with no special foundation requirements • Reduced floor space, easy component accessibility • Site connection point flexibility • Dynamic compression is pulsation-free • Essentially vibration-free 	<ul style="list-style-type: none"> • Require additional, external speed-changing gearbox for drivetrain input • Use of large pulsation dampers to reduce pressure fluctuations • Multiple cylinders require more space for installation • Require large and deep foundation to handle heavy weight and unbalanced forces • Precautions must be taken to prevent transmission of vibration to other equipment

Low Compressor Operating Lifecycle Cost

- Excellent efficiencies at full load, part load and no load
- Low maintenance cost
- Increased uptime from high-reliability design
- No sliding or rubbing parts in the compression process that can cause wear and efficiency loss

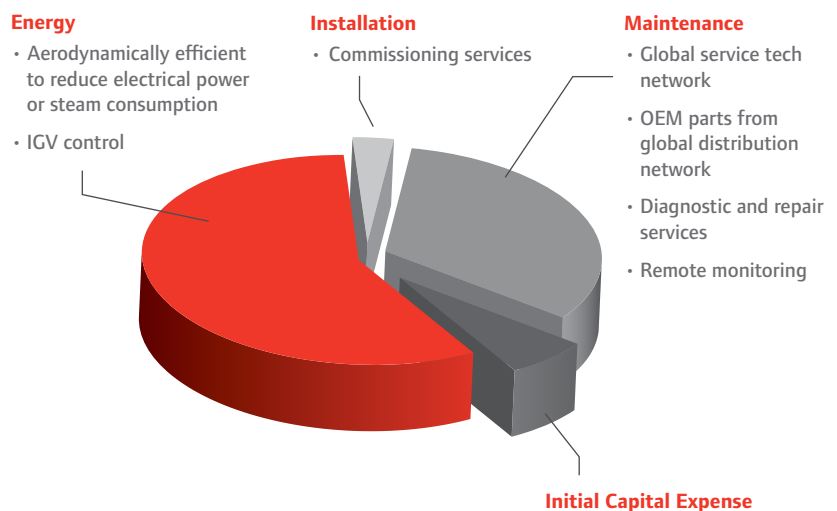

MSG COMPRESSOR APPLICATIONS



We offer a broad portfolio of reliable centrifugal products that is designed to meet the requirements of your air separation application. With more than 40,000 centrifugal installations worldwide, Ingersoll Rand's products are proven in a number of different applications.

Air Separation

Atmospheric gases are separated by a process where air is condensed, cooled and separated by molecular weight in a cold box. The gases are then compressed for storage, transportation or further processing. MSG compressors are used for many purposes, including the main air compressor, booster air compressor, nitrogen gas compressor, nitrogen recycle compressor and argon gas compressor.

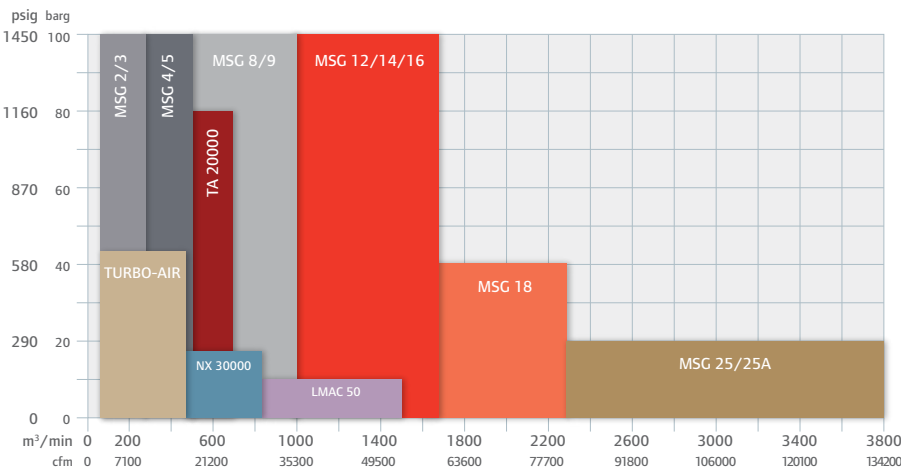
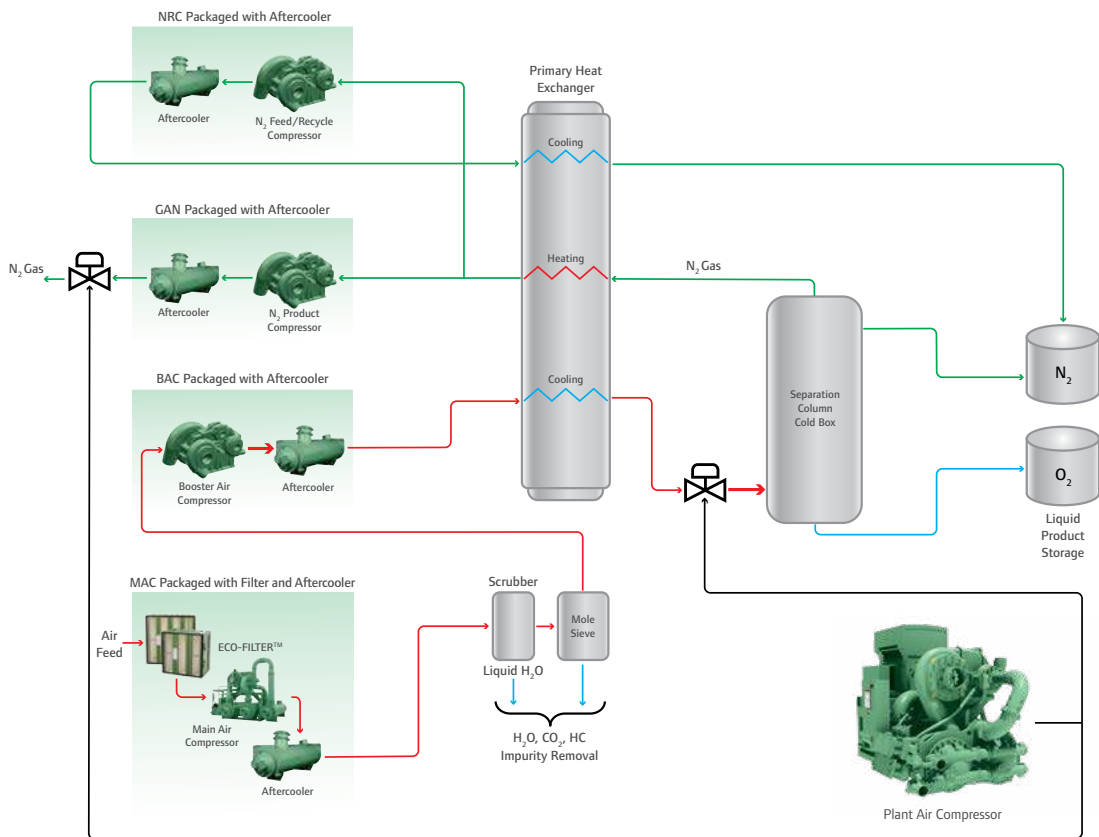

MSG Performance Ranges

MSG compressors can be custom engineered to meet a broad range of pressure and flow process conditions. The chart to the left details the coverage of our specific MSG models.



SUPERIOR CENTRIFUGAL COMPRESSOR DESIGN



Multi-stage geared (MSG) compressors represent the latest technology, offering significant advantages over outdated, less efficient and more costly compressor designs.

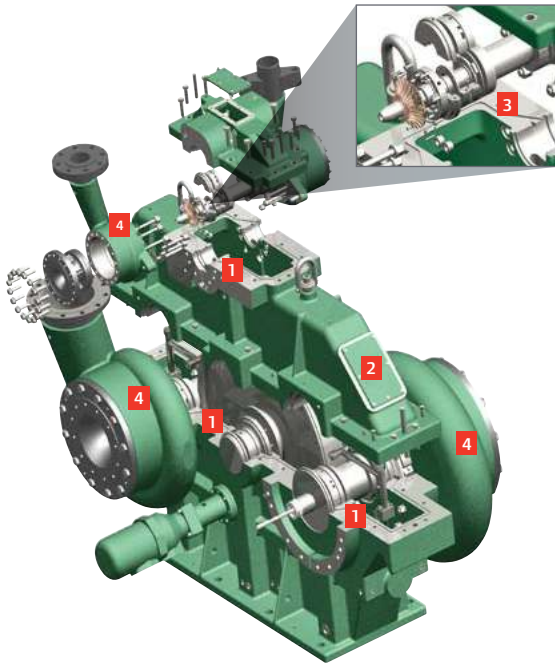

Independent Compression Stages

MSG technology separates each compression stage as its own “mini-compressor”, improving performance.

- 1 One, two or three rotors with up to six independent stages per gearbox. Rotating speed is optimised to match impeller/diffuser design
- 2 Horizontal split line(s) provide easy access to parts for inspection and maintenance
- 3 Each stage is independently sealed
- 4 Scrolls and aerodynamic components are selected and engineered for each specific stage process requirement

Intercooling

Gas may be cooled after every stage to assure a high isothermal efficiency and better gas flow.

- 1 Compressor inlet
- 2 1st stage compressor volute
- 3 Coolant in
- 4 Coolant out
- 5 1st stage intercooler
- 6 2nd stage compressor volute
- 7 2nd stage intercooler
- 8 3rd stage compressor volute
- 9 Compressor discharge

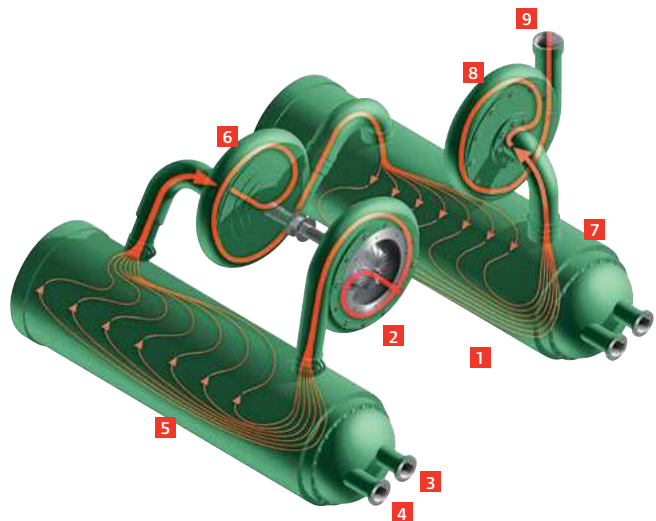

Multiple Process Capability

Multiple processes handled by a single compressor decrease the energy cost of running and maintaining additional machinery, reduce installation footprint and decrease maintenance costs.

MSG compressors are trusted for multiple process applications in the air separation industry, including:

- MAC/BAC
- MAC/GAN
- N2 Feed/Recycle
- and many others...

MSG FEATURES AND BENEFITS

With experienced design teams and numerous available configurations, our MSG compressors are application engineered to deliver the performance and quality you need.



MSG CENTRIFUGAL COMPRESSORS

The Right Compressor for Your Application

MSG compressors for air separation applications are custom-engineered to meet specific process requirements, optimising critical design criteria.

What Makes Our MSG Compressors Unique

Long Lasting Components

- Robust rotating components
- Reliable lubrication system
- Multiple seal options



Power Saving Designs

- Variable inlet guide vanes
- Efficient tapered thrust collars



Simplified Operation

- Intuitive control
- Easy maintenance heat exchangers



View Products
See our portfolio of MSG centrifugal compressors

Industry-leading Features

Our MSG NX 30000 centrifugal compressor, as well as our entire portfolio of compressors for air separation and industrial gas solutions include unique features specific to your application—learn more on the following pages.

- | | |
|--------------------------------------|--------------------------------------|
| 1 Robust rotating components | 4 Lubrication system |
| 2 Variable inlet guide vanes | 5 MAESTRO™ compressor control |
| 3 Process gas heat exchangers | |

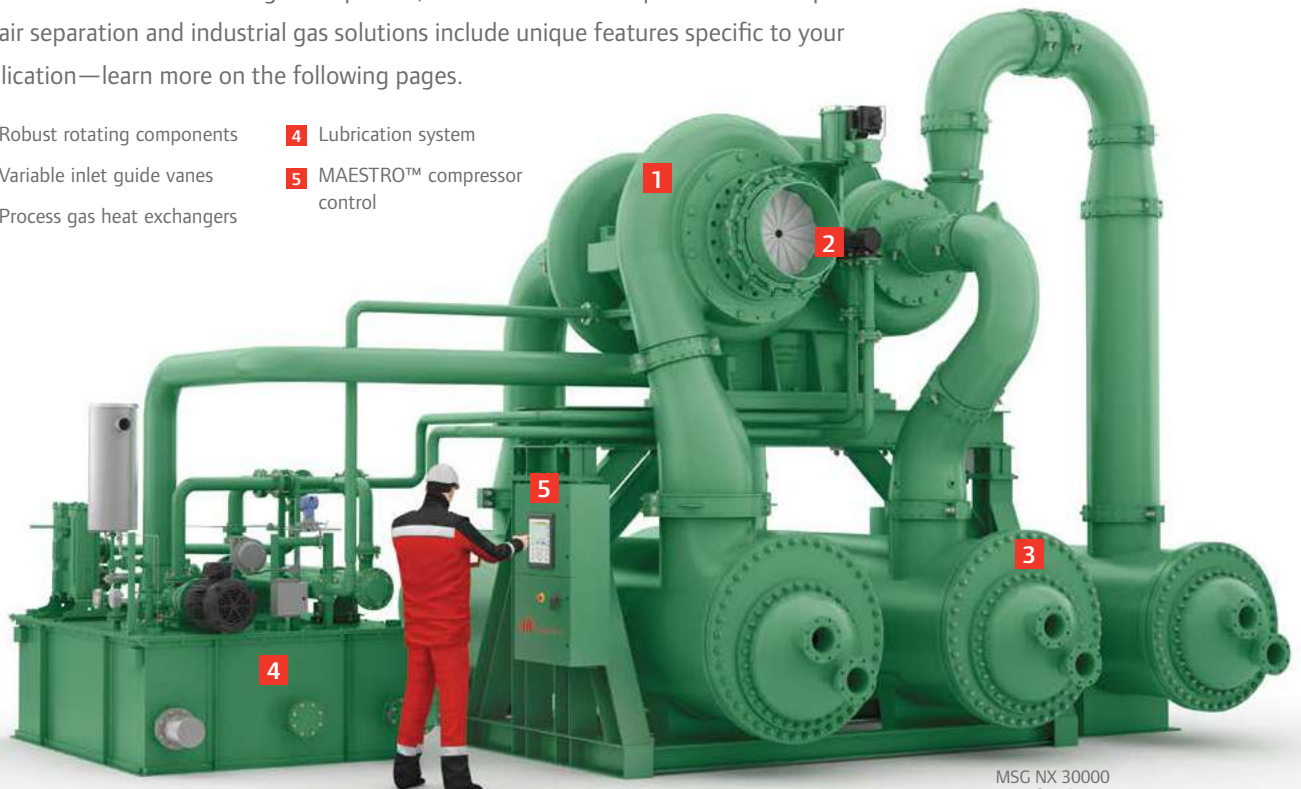

MSG NX 30000 centrifugal compressor

1 Robust Rotating Component Design

- High-efficiency AGMA 13 gearing
- Five-axis milled impellers
- Split seal and bearing design for simplified inspection
- Non-contacting gas and oil seals
- Stainless steel rotation compression elements

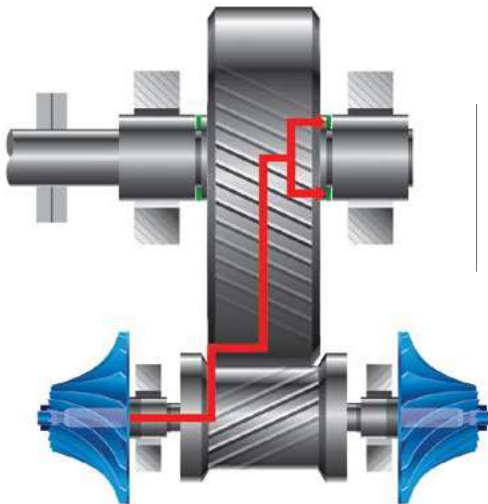
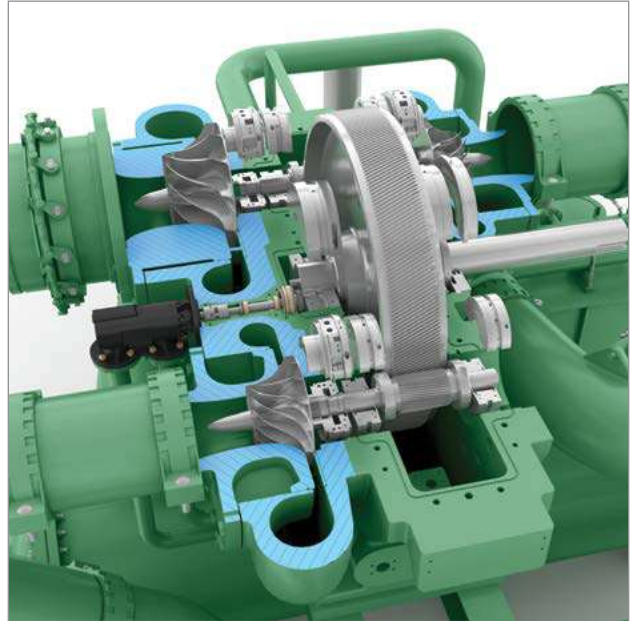

Tapered Rider Ring Thrust Collars

- Symmetrical design cancels out power-robbing thrust loads
- Small remaining net thrust transferred by oil wedge from tapered thrust collar to bull gear
- Net thrust absorbed by low speed thrust bearing
- Balanced design saves power while maximising mechanical integrity

Reliable Gas Seal Design Options

- Plain labyrinth-style
- Abradable (babbitted) labyrinth-style for low leakage
- Buffering and educting arrangements for process gas recovery
- Dry-face seals for maximum sealing
- Tandem and backup seal arrangements for added protection

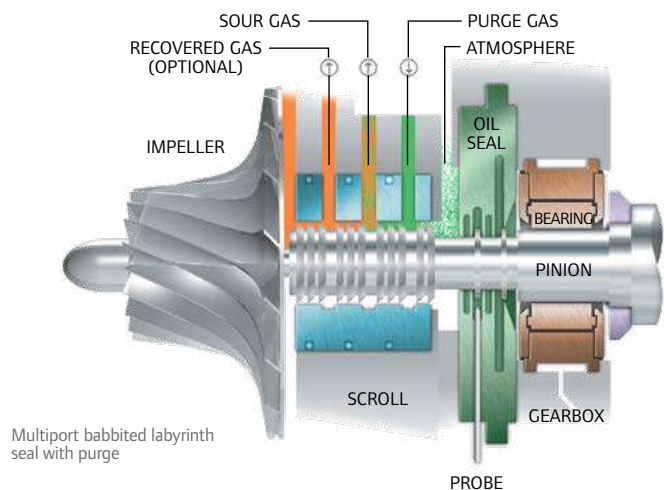

MSG compressors are designed with features that minimise your total cost of ownership through lower energy costs, reduced maintenance and simplified controls. These features are inherent in the centrifugal design and are further enhanced by Ingersoll Rand's more than 60 years of centrifugal expertise.

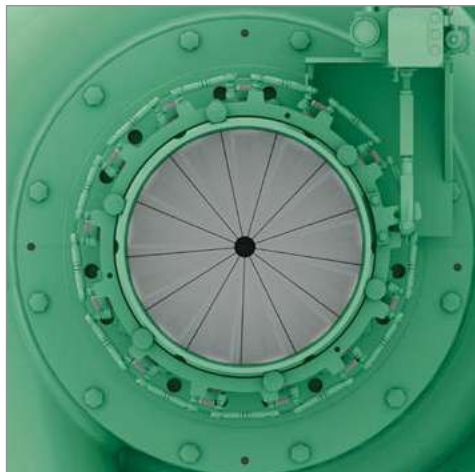

2 Cost-saving Variable Inlet Guide Vanes

- Up to 9% power savings compared to alternative throttling technology
- Pre-rotate the gas stream in the same direction
- Power savings realised when operating under off-design-day (throttled) conditions
- Power savings in turndown or during cold temperature days

3 Efficient, Accessible Heat Exchangers

- Extended-surface, plate-fin design provides increased heat transfer with reduced space requirements
- Water-in-tube cooler designs allow for easy cleaning in areas with poor water conditions
- Accessible, smooth-bore tubes are easily rodded with bundles in place
- Compliant with global pressure vessel regulations (ASME, PED, GB, CU TR, KOSHA and more)



4 Customisable Lubrication System

- Includes an oil reservoir, mechanical oil pump, electric full-flow auxiliary oil pump, fixed-bundle oil cooler, full-flow oil filter, safety devices, and instrumentation for safe compressor operation
- Welded interconnecting piping in carbon steel or stainless steel
- Can be designed to meet custom specification, such as, API 614

5 Intuitive MAESTRO™ Compressor Controls

- System features a setup wizard for quick configuration during installation
- Built-in web server enables remote monitoring (on network)
- 10" color graphic display provides easy monitoring
- Built-in USB port for system configuration and data historian export
- Capable of monitoring and controlling the total system across multiple compressors
- Available in three control methods: constant pressure, auto/dual and mass flow
- PLC options available

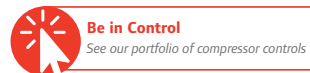

Compressor Quality Assured

Since the early 2000s, Ingersoll Rand has been manufacturing highly reliable MSG centrifugal compressors in China. In 2019, as part of our commitment to provide customers with a strong local presence, we expanded the Wujiang complex located in Suzhou to include a new state-of-the-art MSG assembly and testing facility. Wujiang employs highly skilled and motivated workers dedicated to producing the highest quality machinery on the market.

Core Competencies:

- Advanced manufacturing capability including both assembly and package fabrication
- Comprehensive test laboratory with large scale test benches capable of full-load and closed-loop testing with various test gases
- Robust engineered-to-order (ETO) process to create custom engineered machinery
- Critical quality certifications, including ISO 9001, ISO 14001 and OHSAS 18001

How else can we prove our commitment to your total satisfaction? By providing the industry's most comprehensive resource for top-notch aftermarket products and field service. Ingersoll Rand's extensive network of highly skilled technicians and authorised representatives is at your service at over 80 locations worldwide.

Field Service

Ingersoll Rand's field service team offers the expertise and skills required to ensure proper compressor operation and process integration. Our field service technicians are trained experts specialising in the technical coordination of on-site compressor services, including:

- Installation
- Startups
- Vibration analysis
- Turnaround inspections
- Field balancing
- Drive motor alignment
- Control system services
- Performance evaluation
- Preventative maintenance
- Diagnostic checks



Learn More
Find out about our field service capabilities



A field service technician evaluates instrument readings on a 5-stage MSG-3 carbon monoxide compressor.

Global Service Centers

Servicing centrifugal compressors requires high levels of expertise and precision to maintain tight manufacturing tolerances and ensure compressor performance. Ingersoll Rand has the facilities, equipment and experience strategically located throughout the globe to provide a complete range of services from simple parts inspections to complete compressor overhauls.

Benefits of Our OEM Service Centers

- Over 60 years of knowledge and expertise
- Access to original design specifications
- Complete service history to ensure accuracy
- In-house rework performed with proper equipment
- Genuine OEM replacement parts
- Full mechanical and aerodynamic testing capabilities
- Globally located — North Carolina, United States; Milan, Italy; Ahmedabad, India; Shanghai, China





Whether your compression requirements have changed, or you are looking for increased efficiency, Ingersoll Rand offers a variety of performance-enhancing solutions that can improve operating efficiency.

Performance Enhancing Upgrades

Aerodynamic Modifications

As plant processes or job site locations change, so do process gas requirements. Ingersoll Rand offers a variety of aerodynamic modifications to adjust your existing performance to meet current process gas demands with optimal operating efficiency. These include re-rates to meet higher or lower pressure/flow requirements, airend upgrades for greater turndown range and increased rise to surge, as well as our custom 5-axis milled impellers that can provide improved performance.

Additional Upgrades

- **Duplex Oil Filters** - Simplify maintenance and maximise uptime with on-the-fly filter replacement
- **Duplex Oil Coolers** - Keep your compressor running during routine oil cooler maintenance
- **Control Valves** - Improve control precision with stepper motor and modulating blow-off valve technology
- **Cooler Bundles** - Improve performance or guard against corrosion with a variety of material and coating options

Inlet Guide Vanes

Our innovative inlet guide vanes (IGV) replace conventional inlet butterfly valves (IBV) with substantial potential for energy savings (up to 9%). This allows the compressor to take advantage of opportunities for energy savings when reduced flow is permitted or on days when the ambient conditions are favorable versus the design point.

OEM Replacement Parts & Accessories

As the OEM for MSG compressors, Ingersoll Rand can provide exact replacement parts for your maintenance and service requirements. We've got you covered for everything from a replacement bullgear to a missing bolt. We've maintained detailed records for every compressor we have ever built since the day it was delivered. We also maintain extensive inventories in strategic locations around the world backed by our OEM guarantee.



[View OEM Parts](#)

See our portfolio of compressor accessories

Excellence in Engineering

Maximise your total cost of ownership with Ingersoll Rand's extensive knowledge of compressor system design, applications, technologies and services—**we are your trusted partner in air separation and industrial gas systems.**





About Ingersoll Rand Inc.

Ingersoll Rand Inc. (NYSE:IR), driven by an entrepreneurial spirit and ownership mindset, is dedicated to helping make life better for our employees, customers and communities. Customers lean on us for our technology-driven excellence in mission-critical flow creation and industrial solutions across 40+ respected brands where our products and services excel in the most complex and harsh conditions. Our employees develop customers for life through their daily commitment to expertise, productivity and efficiency. For more information, visit www.IRco.com.

IngersollRand.com



Member of Pneurop



Ingersoll Rand, IR, the IR logo, MAESTRO, MSG and MSG TURBO-AIR are trademarks of Ingersoll Rand, its subsidiaries and/or affiliates. All other trademarks are the property of their respective owners.

Ingersoll Rand compressors are not designed, intended or approved for breathing air applications. Ingersoll Rand does not approve specialised equipment for breathing air applications and assumes no responsibility or liability for compressors used for breathing air service.

Nothing contained on these pages is intended to extend any warranty or representation, expressed or implied, regarding the product described herein. Any such warranties or other terms and conditions of sale of products shall be in accordance with Ingersoll Rand's standard terms and conditions of sale for such products, which are available upon request.

Product improvement is a continuing goal at Ingersoll Rand. Any designs, diagrams, pictures, photographs and specifications contained within this document are for representative purposes only and may include optional scope and/or functionality and are subject to change without notice or obligation.